

"TONALITY®"-Julkisivulaatta
T-LINE-Kiinnitysjärjestelmä
 (pohjautuu ADS-kiinnitysjärjestelmään)
 Yleiskuva

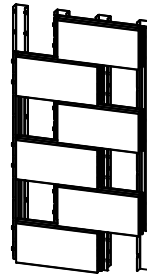

Nro. T-Line 600-01
 Mittakaava: 1:5 DIN A3

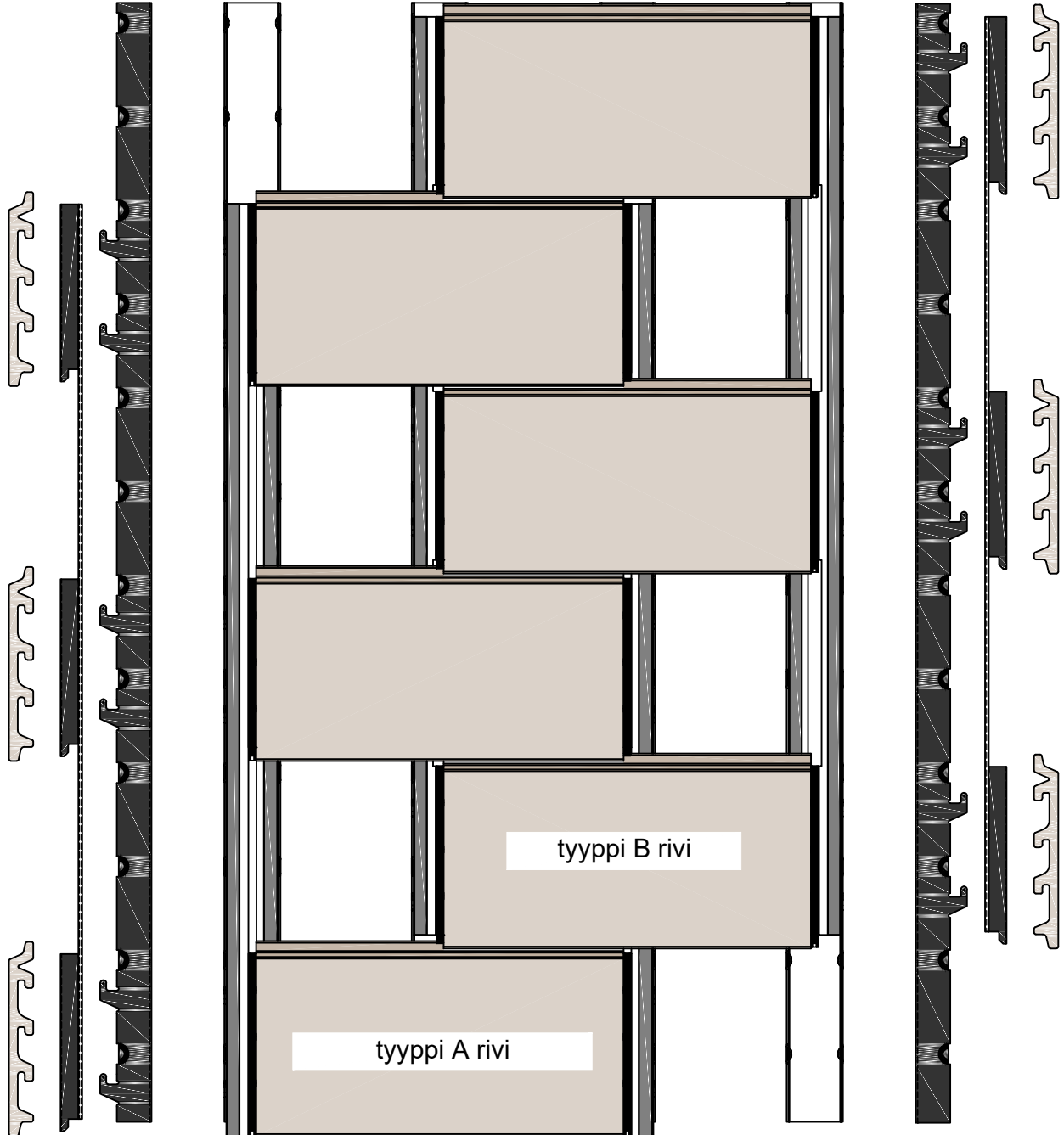

Tyyppi A
 kokoonpano

Tyyppi B
 kokoonpano

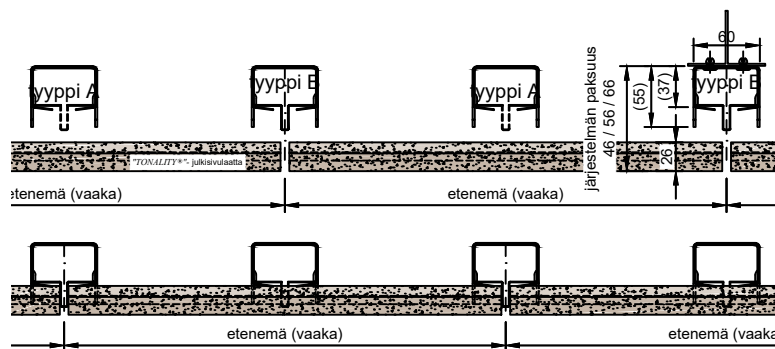

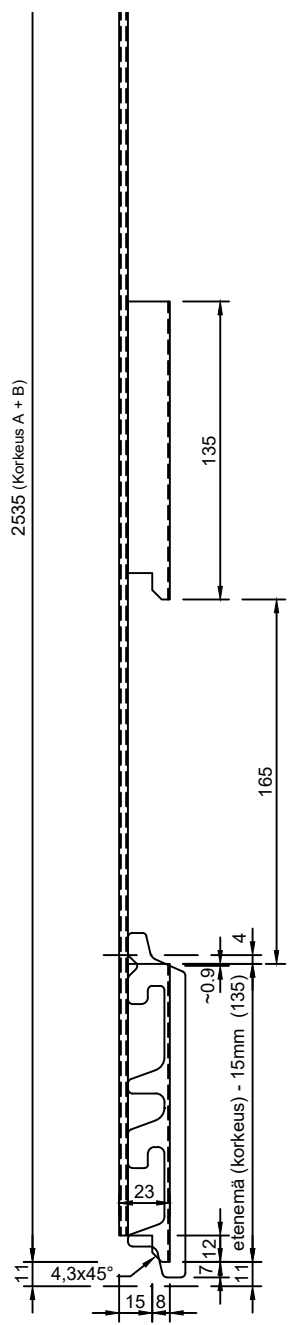
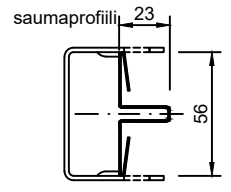
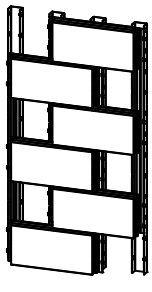
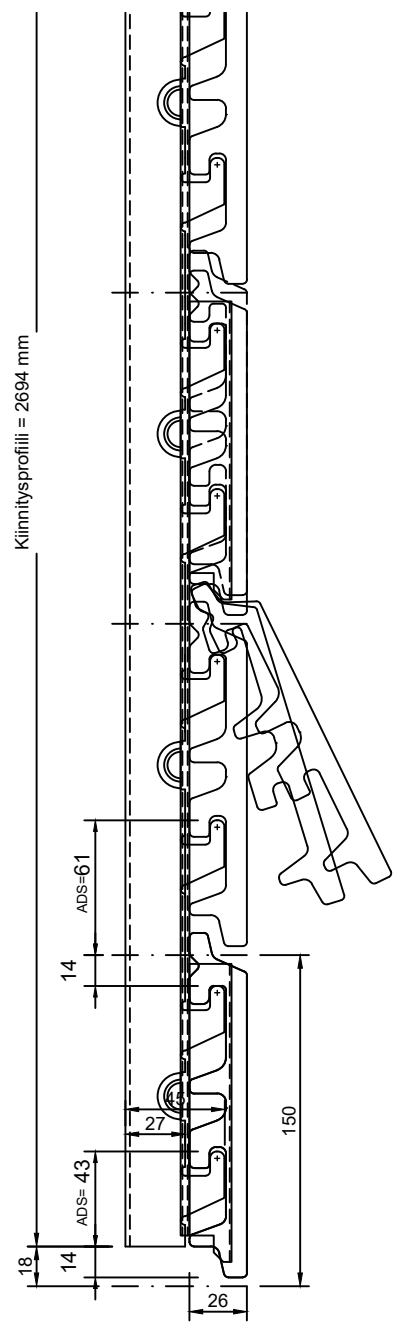
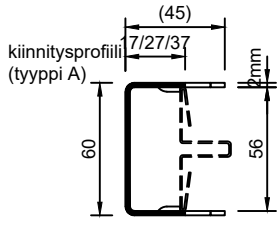
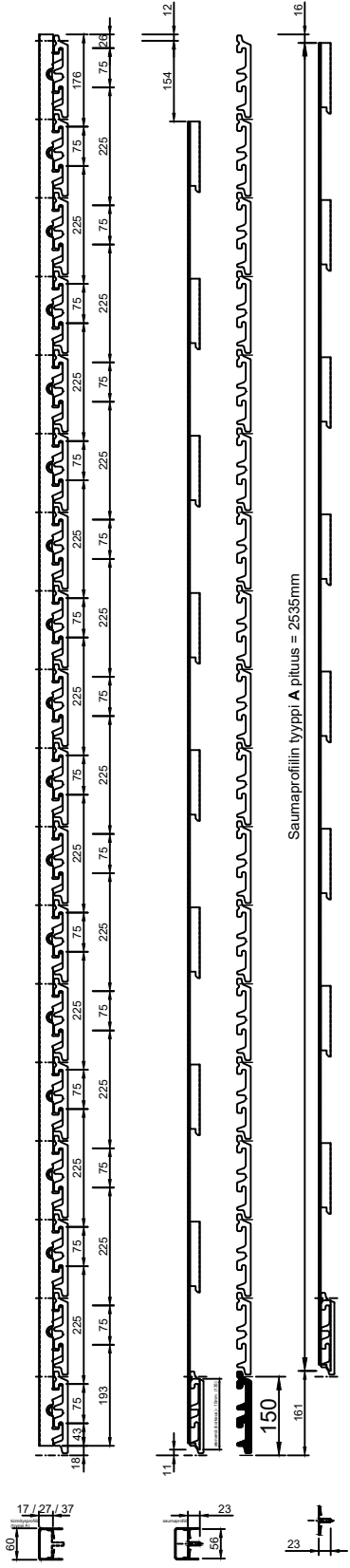

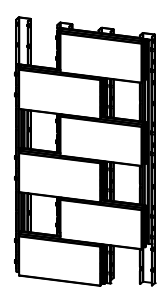
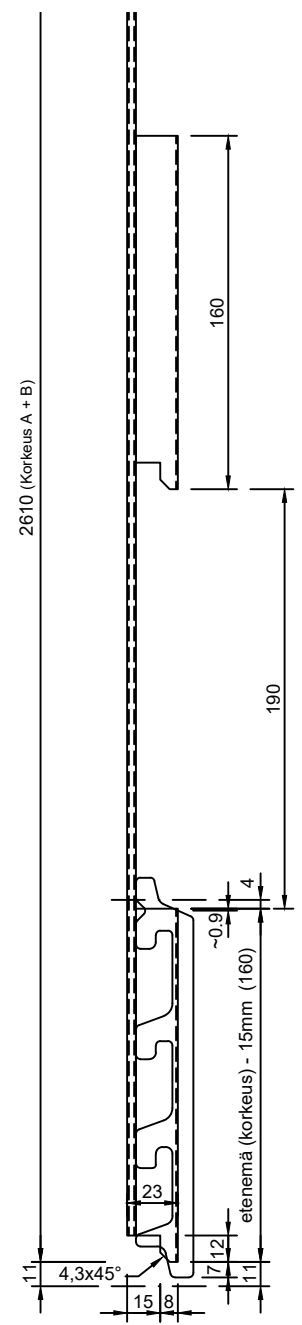
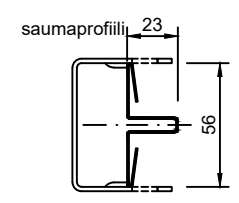
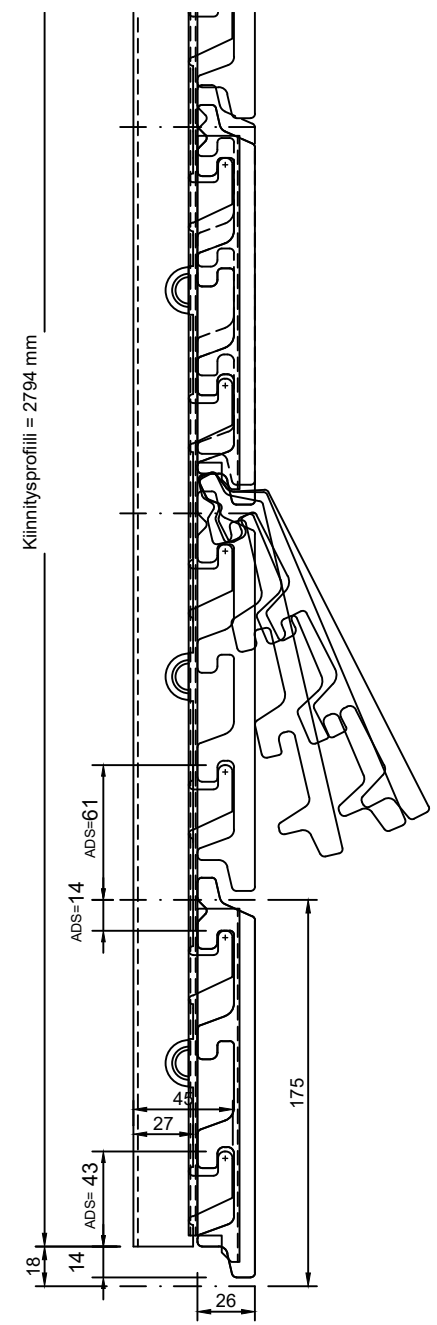
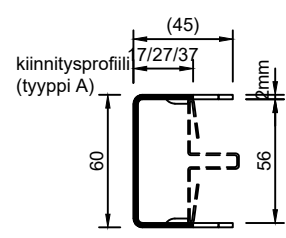
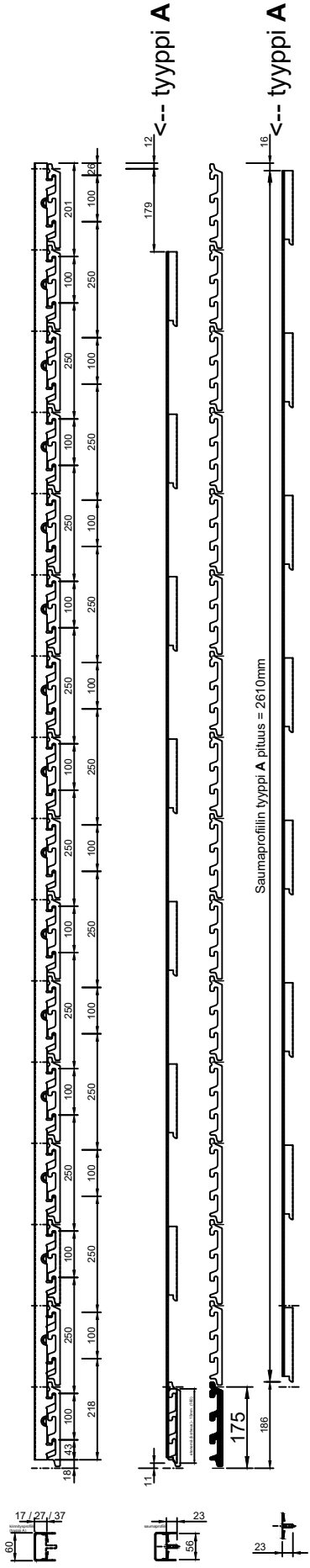

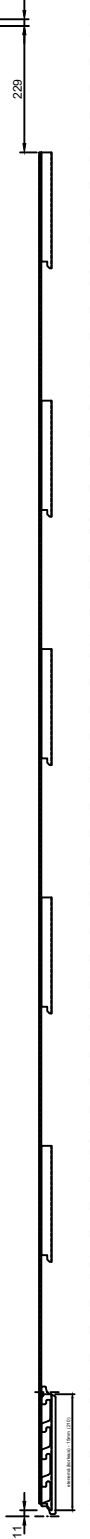
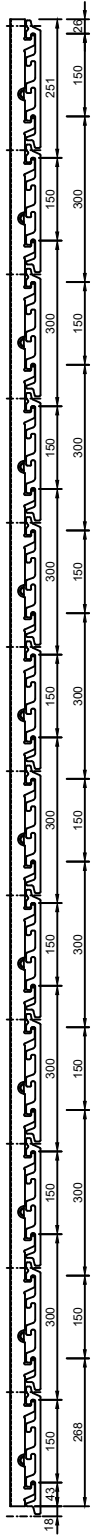

<-- tyyppi A

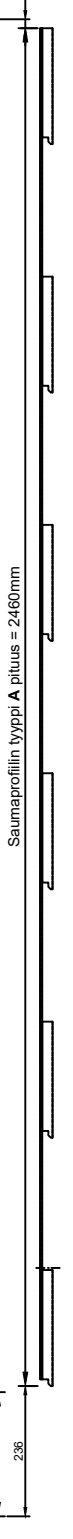

<-- tyyppi A

Saumaprofiilin tyyppi A pituus = 2460mm

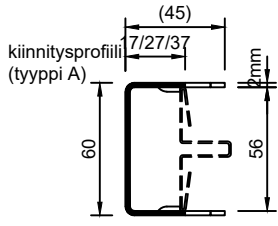

kiinnitysprofiili (tyyppi A)

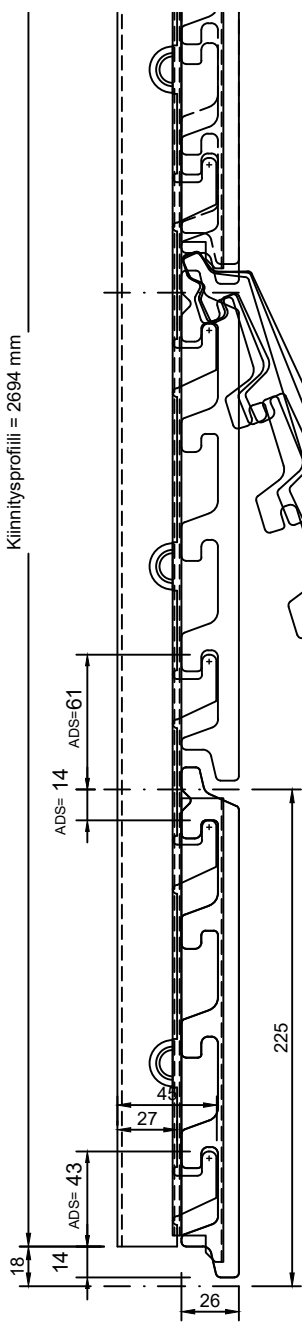

Kiinnitysprofiili = 2694 mm

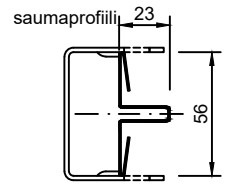
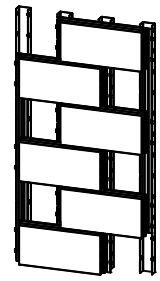

saumaprofiili

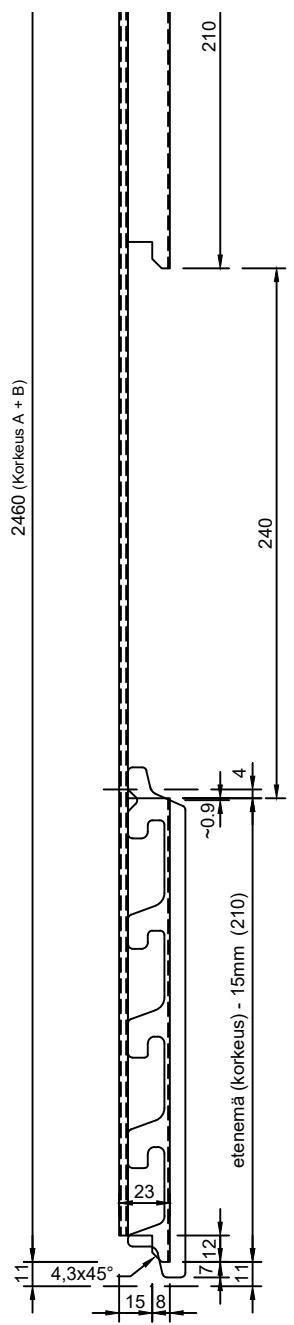

2460 (Korkeus A + B)

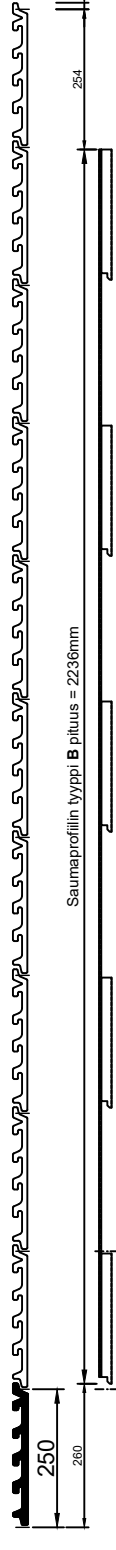
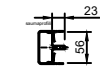
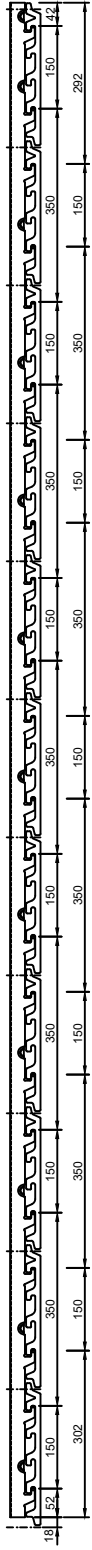

Saumaprofilin tyyppi B pituus = 2236mm

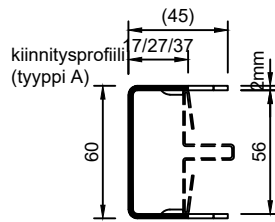

Kiinnitysprofili = 2744 mm

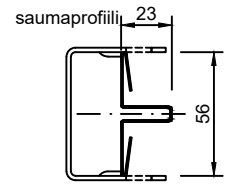
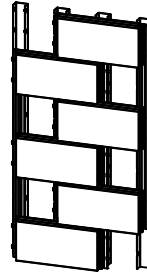
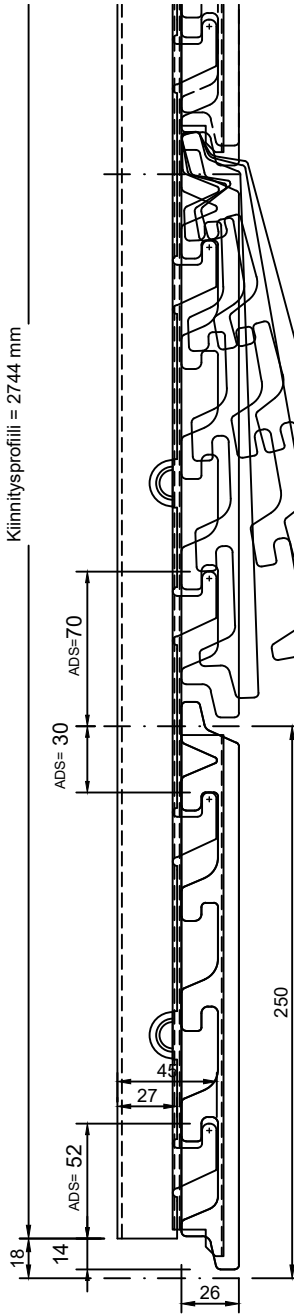

2736 (Korkeus A) / 2236 (Korkeus B)

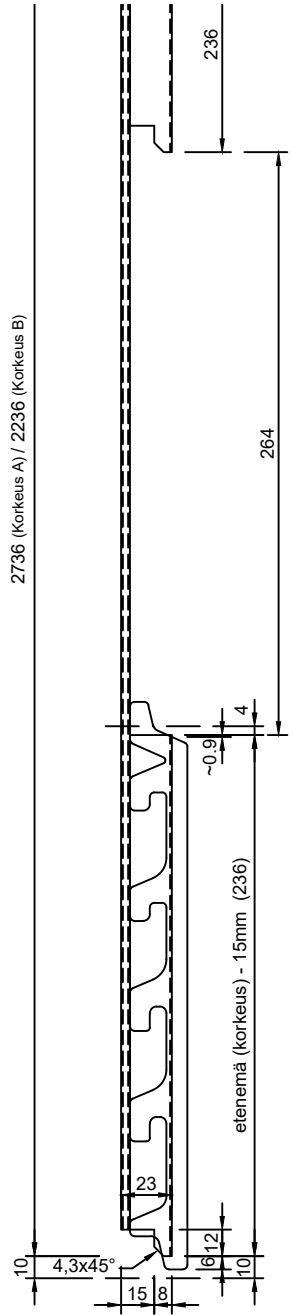

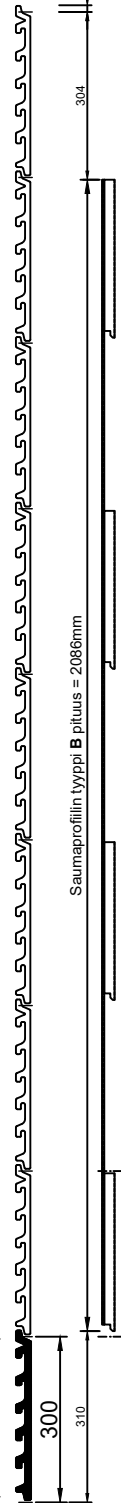
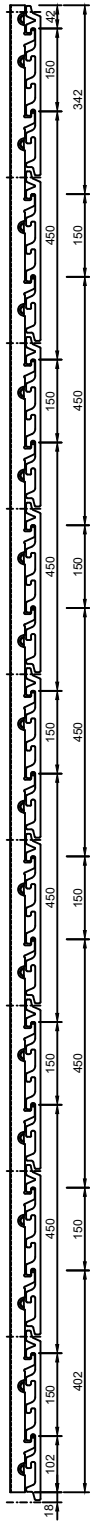

<-- tyyppi A

<-- tyyppi B

Saumaprofiilin tyyppi B pituus = 2086mm

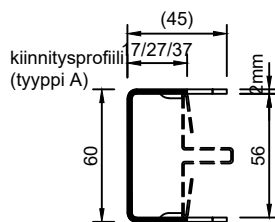

kiinnitysprofiili (tyyppi A)

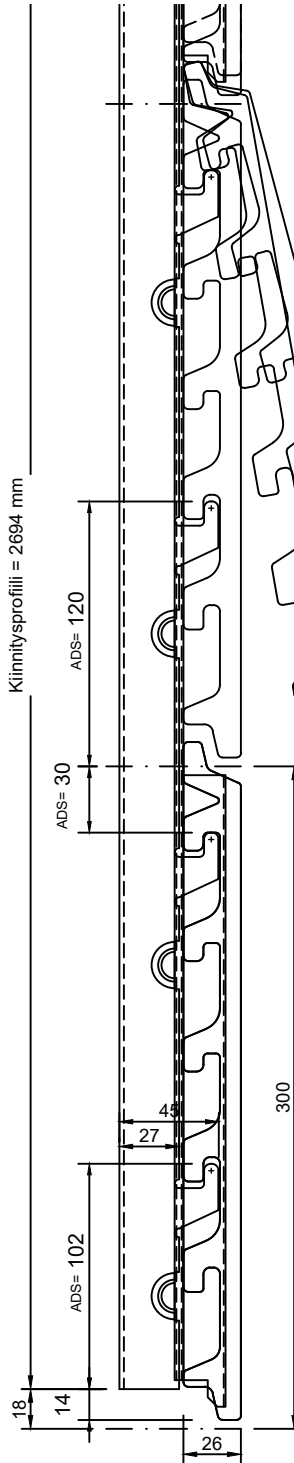

Kiinnitysprofiili = 2694 mm

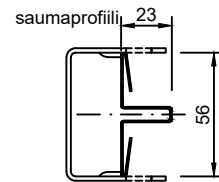
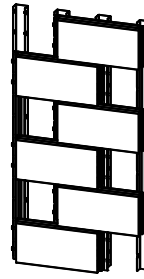

saumaprofiili

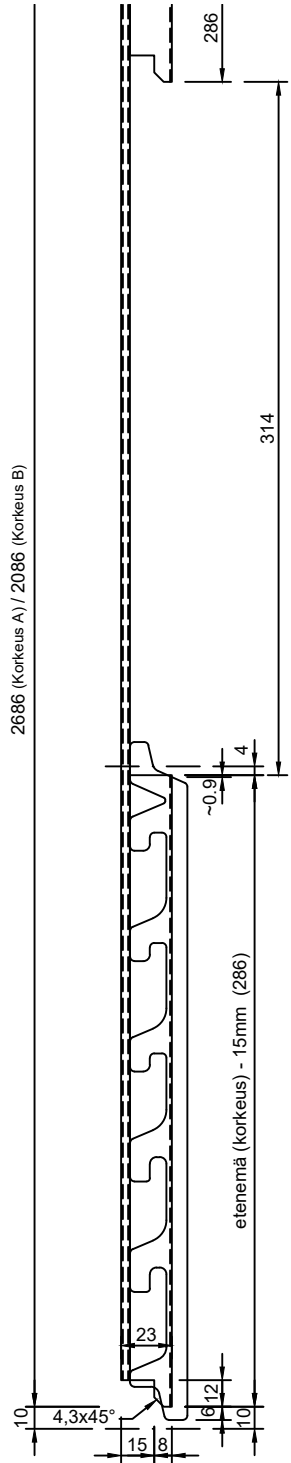

2686 (Korkeus A) / 2086 (Korkeus B)

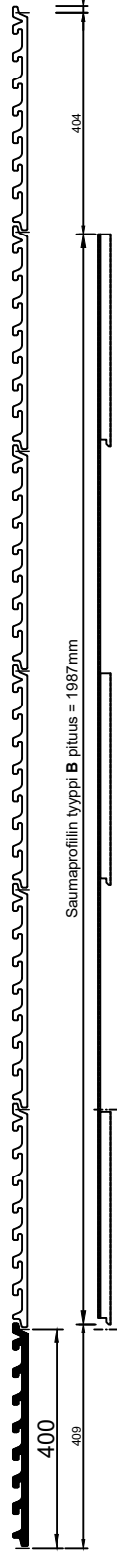
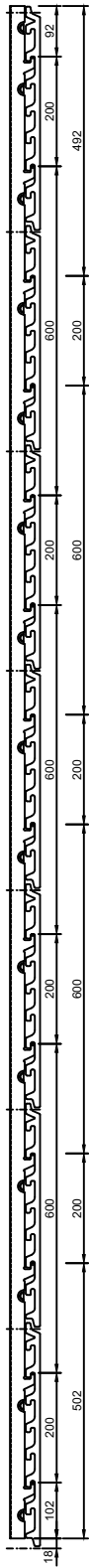

Saumaprofiilin tyyppi B pituus = 1987mm

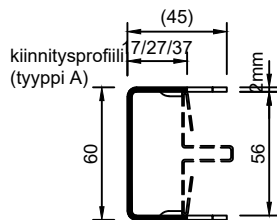

Kiinnitysprofiili = 2794 mr

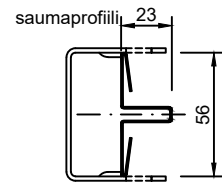
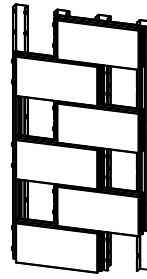
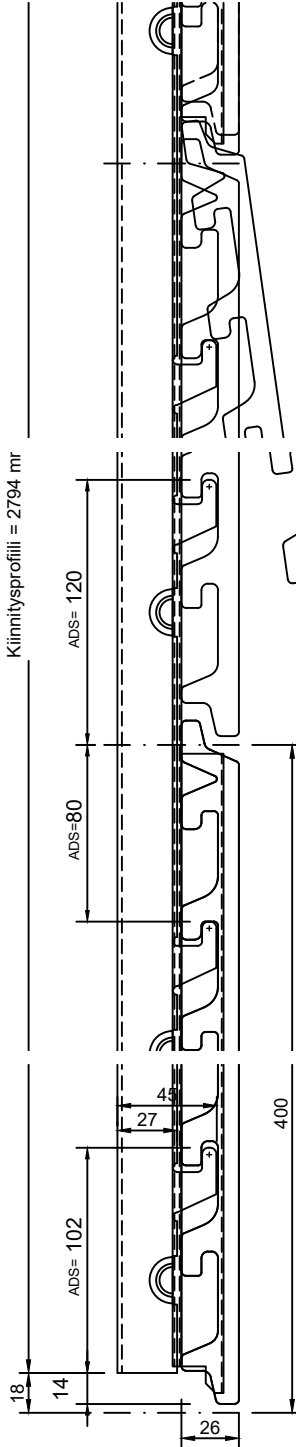

2787 (Korkeus A) / 1987 (Korkeus B)

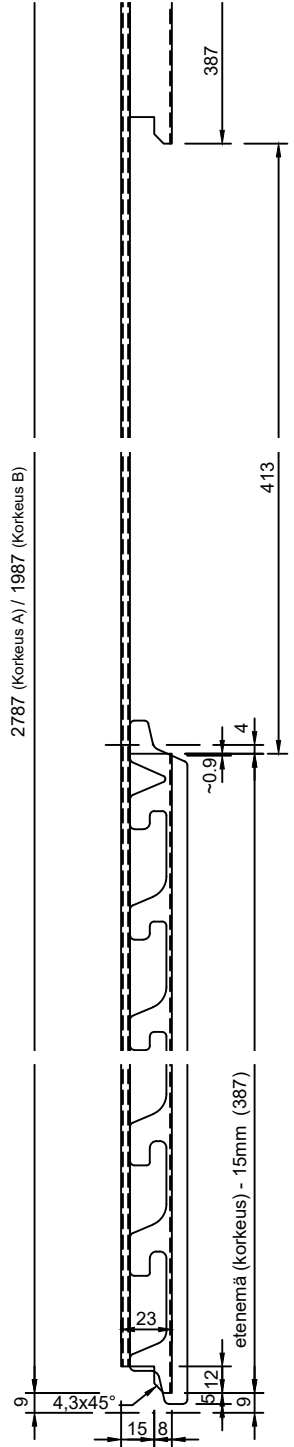

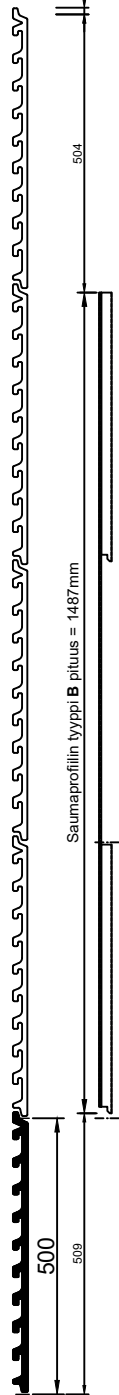
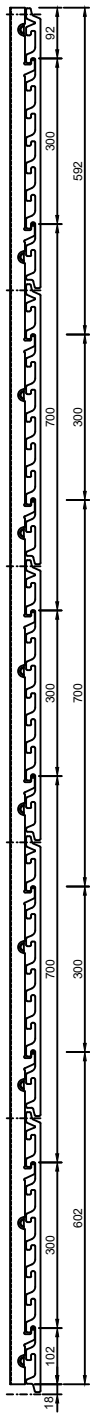

<-- tyyppi A

<-- tyyppi B

kiinnitysprofiili (tyyppi A)

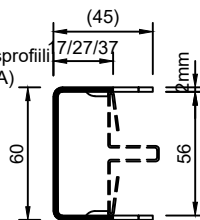

Kiinnitysprofiili = 2494 mm

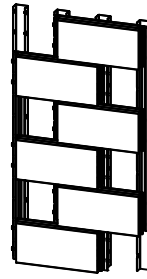
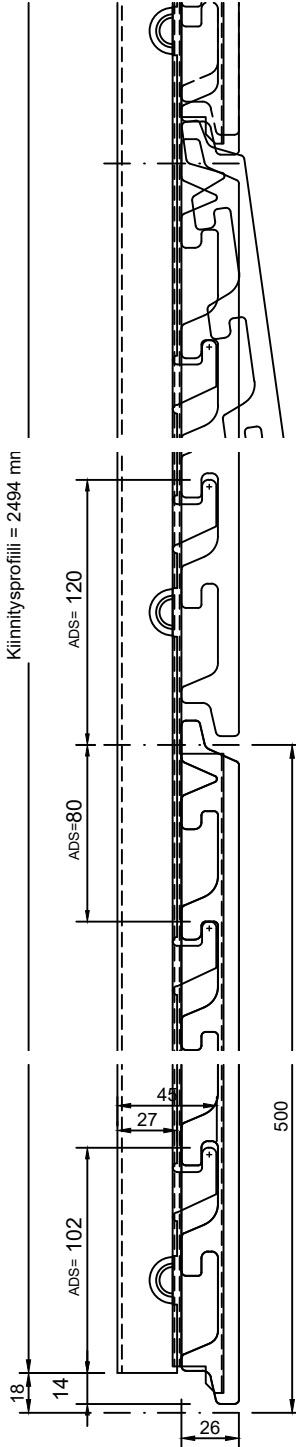

saumaprofiili 23

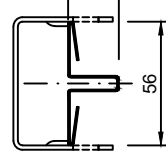

2487 (korkeus A) / 1487 (korkeus B)

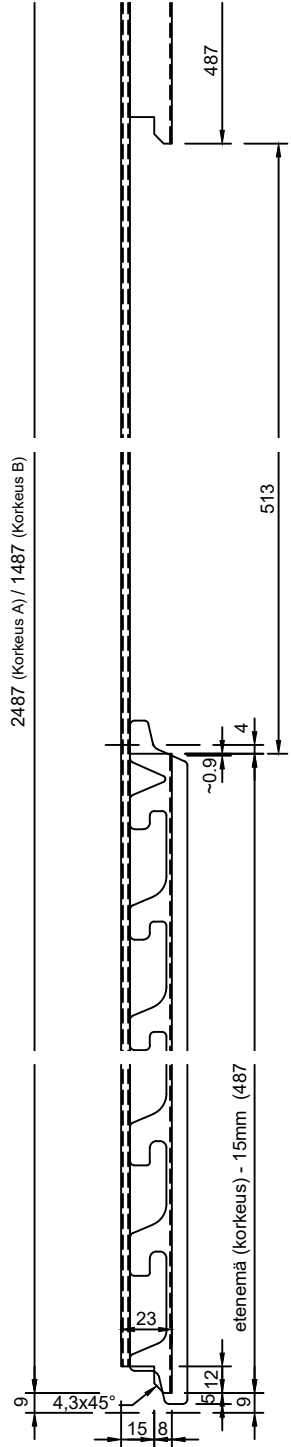

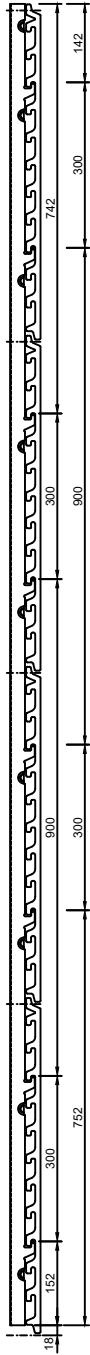

<-- tyyppi A

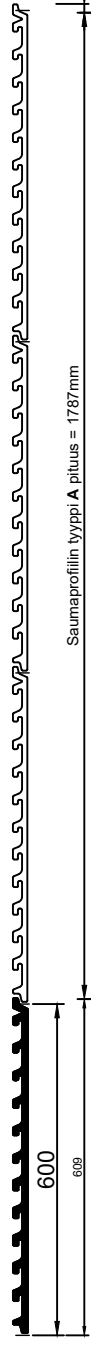

<-- tyyppi A

Saumaprofiilin tyyppi A pituus = 1787mm

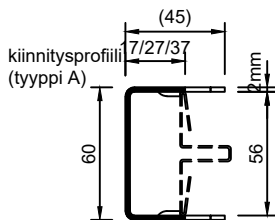

kiinnitysprofiili (tyyppi A)

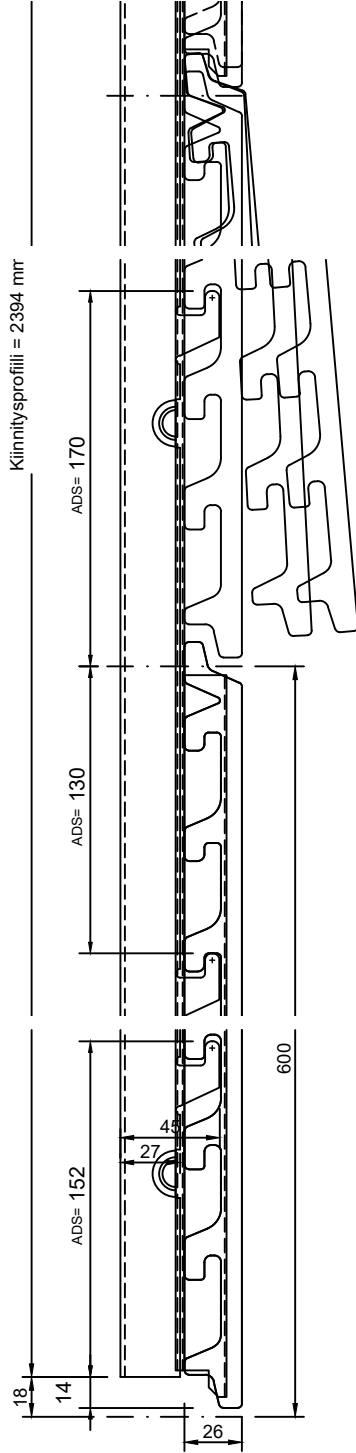

Kiinnitysprofiili = 2394 mrr

saumaprofiili

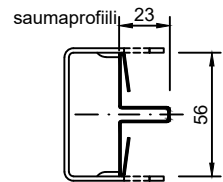

1787 (Korkeus A + B)

